

Continental Disc Corporation®  
**PRODUCT SELECTION GUIDE**



**Continental Disc®  
Corporation**

Continental Disc Corporation manufactures rupture discs to our customers' specifications to help protect vessels, equipment and systems against damaging overpressure conditions.

## QUALITY

Quality starts with our first contact with you. That quality is an integral part of every step we take to provide you with what you expect to receive. All manufacturing is performed under an approved ISO 9001 Quality Assurance System. Continental Disc Corporation can supply rupture discs certified to the standards of the ASME, the European Pressure Equipment Directive, the China Manufacture License, the 3A Sanitary Standards Council, and many others.

## SERVICE

A commitment to supply the services you expect:

- Technical assistance, training and support
- Fast, technical, easily understood quotations
- Providing the product to your specifications
- Shipping schedules that are unmatched in the industry

Continental Disc Corporation offers an emergency service program to meet your needs. Shipping schedules are adjusted daily to meet your emergency requirements.

## QUALITY, SERVICE, TECHNICAL SUPPORT, INNOVATIVE PRODUCTS

*These are the benchmarks that enable Continental Disc Corporation to provide you, our customer, with the best possible products and services.*

## TECHNICAL SUPPORT

Our policy is to continuously train in-house and field personnel. This has resulted in Continental Disc Corporation's reputation as a **provider of correct, effective answers to special pressure relief application problems.**

We offer technical seminars for:

- Rupture disc applications
- Custom manufactured products
- Installation and handling
- Maintenance procedures

With a world-wide representative network backed by an in-house technical staff, Continental Disc Corporation can assist in determining the best and most economical rupture disc for your specific needs.

## INNOVATIVE PRODUCTS

We are leading the way to tomorrow! Exclusive products introduced to meet our customers' needs include:

**HPX™ Rupture Disc** ...The premier, most versatile, highest cycling reverse acting rupture disc for either GASEOUS or LIQUID systems.

**LOTRX® Rupture Disc**... A scored, reverse acting rupture disc with features that make it ideal for low pressure applications – as low as 1.5 psig (0,103 barg).

**B.D.I.® ALARM SYSTEM**... Immediately notifies operators that a rupture disc has burst.

**CAL-VAC®/POS-A-SET® Rupture Discs**...The industry's first ultralow pressure rupture disc capable of operating in inches of water column.

**QUICK-CHANGE® HOLDER**... For fast, easy rupture disc changeout.

**3-D TAG**...A three-dimensional flow tag of corrosion resistant stainless steel to provide visual verification the rupture disc is properly oriented in the system.





In many cases, the type of rupture disc for a given application may be found using the following steps:

---

---

1. To select the proper rupture disc for any application, it is important to begin by writing down specific data about your system.
  - a. Maximum allowable working pressure of the vessel (MAWP): psig, barg, kg/cm<sup>2</sup>, etc.
  - b. Maximum operating conditions: Pressure: psig, barg, kg/cm<sup>2</sup>, etc.  
Temperature: degree of Fahrenheit, Centigrade, etc.
  - c. Rupture disc burst conditions: Pressure: psig, barg, kg/cm<sup>2</sup>, etc.  
Temperature: degree of Fahrenheit, Centigrade, etc.
  - d. Process media: liquid or gas
  - e. Backpressure and/or vacuum conditions: psig, barg, kg/cm<sup>2</sup>, etc.

- f. Service conditions: static, cyclic or pulsating. If known, what is the frequency of cycles or pulsations
  - g. Code/Standards requirements: ASME Section III or VIII, BSI, EN, ISO, TUV, JIS, DIN, KOSHA, GOST, CRN, etc.
  - h. Appropriate rupture disc and holder material to meet corrosive and/or temperature requirements of the application
  - i. Flange connection type and class at rupture disc installation
  - j. Other special conditions
2. Calculate the system operating to rupture disc burst pressure ratio.

















$$\% \text{ Ratio} = \frac{\text{maximum operating pressure} \times 100}{\text{minimum rupture disc burst pressure}}$$

3. Refer to pages 4 and 5 of this guide and make a tentative rupture disc selection from the chart using the system data summarized in steps 1 and 2.

4. Check the appropriate Continental Disc Corporation product literature to assure the rupture disc burst pressure is within the minimum and maximum pressure capability of the selected rupture disc type and material.
5. Select required options or accessories for both the rupture disc and holder, such as coating, lining, J-Hook, excess flow valve, vacuum support, etc.
6. Refer to the specific Continental Disc Corporation product literature for detailed ordering information.

The final selection of a rupture disc and holder is the responsibility of the customer. If you need assistance or additional technical information, consult your Continental Disc Corporation representative or the factory.



PROCESS ENVIRONMENT	SIZE	BURST PRESSURE RANGE	RECOMMENDED MAX. OPERATING TO BURST PRESSURE RATIO	MANUFACTURING RANGE	VACUUM SUPPORT REQUIRED TO WITHSTAND FULL VACUUM	STANDARD MATERIALS**								CONTINENTAL DISC CORPORATION RUPTURE DISC
						ALUMINIUM	MONEL	INCONEL	NICKEL	316 SS	HASTELLOY C-276	TANTALUM	GRAPHITE	
Gas/vapor or liquid (static, cyclic or pulsating)	1" - 8" 25 - 200 mm	15 - 1000 psig 1,03 - 68,9 barg	90 or 95%	ZERO -5% -10%	NO		◆	◆	◆	◆	◆	◆		
Liquid or Gas (static, cyclic or pulsating)	1" - 12" 25 - 300 mm	15 - 1000 psig 1,03 - 68,9 barg	90%	ZERO -5% -10%	NO		◆	◆	◆	◆	◆	◆		
Liquid or Gas (static, cyclic or pulsating)	1" - 8" 25 - 200 mm	1.5 - 39.9 psig 0,103 - 2,75 barg	90%	ZERO -5% -10%	NO*		◆	◆	◆	◆	◆			
Gas (static, cyclic or pulsating)	14" - 32" 350 - 800 mm	20 - 1000 psig 1,38 - 68,9 barg	90%	ZERO -5% -10%	NO		◆	◆	◆	◆	◆			
Gas/vapor or liquid (static, cyclic or pulsating)	1" - 3" 25 - 80 mm	10 - 250 psig 0,690 - 17,2 barg	90 or 95%	ZERO -5% -10%	NO		◆	◆	◆	◆	◆	◆		
Liquid or Gas (static, cyclic or pulsating)	1" - 4" 25 - 100 mm	10 - 500 psig 0,690 - 34,5 barg	90%	ZERO -5% -10%	NO*	◆	◆	◆	◆	◆	◆	◆		
Liquid or Gas (static)	1" - 36" 25 - 900 mm	15 - 3600 psig 1,03 - 248 barg	80%	Standard -5% -10%	NO*		◆	◆	◆	◆	◆	◆		
Liquid or Gas (static, cyclic or pulsating)	11/16" - 36" 17,5 - 900 mm	2 - 1440 psig 0,138 - 99,3 barg	80%	Standard 3/4, 1/2, 1/4	YES	◆	◆	◆	◆	◆	◆	◆		
Liquid or Gas (static, cyclic or pulsating)	1/4" - 30" 6 - 750 mm	3 - 80,000 psig 0,207 - 5516 barg	70%	Standard 3/4, 1/2, 1/4	YES	◆	◆	◆	◆	◆	◆	◆		
Liquid or Gas (static, cyclic or pulsating)	1" - 30" 25 - 750 mm	2 - 1440 psig 0,138 - 99,3 barg	80%	Standard 3/4, 1/2, 1/4	YES	◆	◆	◆	◆	◆	◆	◆		
Liquid or Gas (static, cyclic or pulsating)	3" - 12" 80 - 300 mm	1 - 30 inch water column	Within 1 inch W.C. of min. setting	6 inch water column min. /max.	NOT Applicable		◆	◆	◆	◆	◆	◆		
Liquid or Gas (static, cyclic or pulsating)	3" - 12" 80 - 300 mm	1 - 30 inch water column	Within 1 inch W.C. of min. setting	6 inch water column min. /max.	NOT Applicable		◆	◆	◆	◆	◆	◆		
Liquid or Gas (static, cyclic or pulsating)	2" - 36" 50 - 900 mm	1 - 59 psig 0,069 - 4,07 barg	50%	Min./Max.	NO*		◆	◆	◆	◆	◆	◆		
Liquid or Gas (static, cyclic or pulsating)	1/2" - 24" 13 - 600 mm	0,25 - 720 psig 0,017 - 49,6 barg	80%	Standard	NO*							◆		
<b>RUPTURE DISCS FOR MAINTENANCE REPLACEMENT ONLY - SEE PRODUCTS ABOVE FOR NEW APPLICATION REQUIREMENTS</b>														
Liquid or Gas (static, cyclic or pulsating)	1" - 8" 25 - 200 mm	20 - 139 psig 1,38 - 9,58 barg	90%	ZERO -5% -10%	NO		◆	◆	◆	◆	◆	◆		
Liquid or Gas (static, cyclic or pulsating)	1" - 6" 25 - 150 mm	13 - 140 psig 0,896 - 9,65 barg	90%	ZERO -5% -10%	NO	◆	◆	◆	◆	◆	◆	◆		
Gas (static, cyclic or pulsating)	12" - 32" 300 - 800 mm	15 - 1000 psig 1,03 - 68,9 barg	90%	ZERO	NO	◆	◆	◆	◆	◆	◆	◆		

\*Dependent upon burst pressure.

\*\*Materials not indicated or shown may be available by special design. Contact the factory.

CONTINENTAL DISC CORPORATION RUPTURE DISC TYPE	FLOW DIRECTION	COMPATIBLE HOLDERS									RECOMMENDED FOR ISOLATION OF SAFETY RELIEF VALVE		AVAILABLE BURST PRESSURE INDICATOR (B.D.I.®) (1 INCH AND ABOVE)	AVAILABLE ASME® CERTIFICATION
		UNION	INSERT	FULL BOLTED	CLEAN-SWEEP	TITE-SEAL	SCREW TYPE	PRETORQUED	SANITARY	YES	NO			
HPX™			◆						◆		◆		◆	◆
ULTRX®			◆						◆		◆		◆	◆
LOTRX®			◆						◆		◆		(3" - 8" size)	◆
RCS			◆						◆		◆		◆	◆
SANITRX HPX™		No holder required. Installs between standard ferrules.							◆	◆		◆	◆	
SANITRX® SANITRX LP		No holder required. Installs between standard ferrules.							◆	◆		◆	◆	
MICRO X®			◆		◆				◆		◆		◆	◆
COMPOSITE FS			◆		◆	◆	◆	◆	◆	◆	◆		◆	◆
STANDARD 30°		◆	◆	◆	◆	◆	◆				◆		◆	◆
COMPOSITE 30°		◆	◆	◆						◆			◆	◆
CAL-VAC®			◆								◆		◆	
POS-A-SET®			◆						◆		◆		◆	
ENVIRO-SEAL		No holder required. Installs between standard bore companion flanges.							◆	Downstream Only		◆	◆	
GRAFSERT®		No holder required. Installs between standard bore companion flanges.									◆	◆	◆	
MINTRX®			◆								◆		◆	◆
STAR X®			◆								◆		◆	◆
KBA			◆								◆		◆	◆

## TYPE OF DISC

No single type of rupture disc will meet all the numerous applications of an industry. Each type of rupture disc, Tension or Reverse Acting, has its own characteristics and capabilities.

### Tension Type Rupture Discs

Fig. A

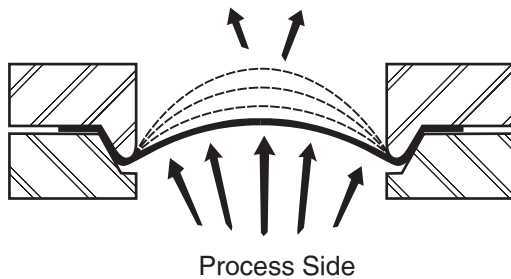
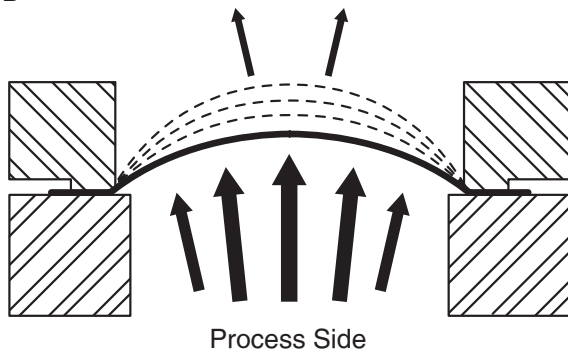

Fig. B



**Tension Type rupture discs** are oriented in a system with the process media pressure against the concave side of the rupture disc (Figure A, 30° Seat; Figure B, Flat Seat). As the process pressure increases beyond the allowable operating pressure, the rupture disc starts to grow. This growth will continue as the pressure increases, until the tensile strength of the material is reached and rupture occurs.

### Reverse Acting Rupture Discs

Fig. A

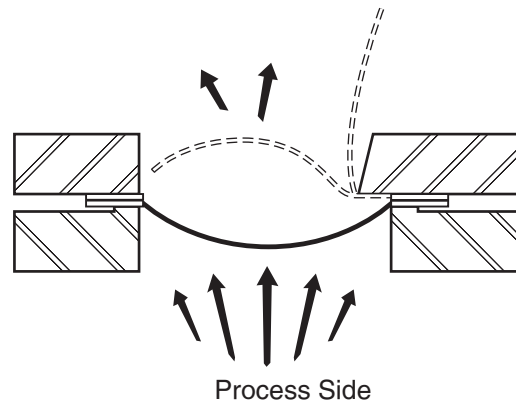

**Reverse Acting rupture discs** are oriented in a system with the process media pressure against the convex side of the disc (Figure C), placing the rupture disc in compression. As the burst pressure rating of the disc is reached, the compression loading on the rupture disc causes it to reverse, snapping through the neutral position and causing it to open by a predetermined scoring pattern.

A reverse acting rupture disc provides some advantages, as compared to tension type rupture discs, which may warrant consideration when selecting a rupture disc.

These advantages include:

- Zero manufacturing range allowing the rupture disc to operate up to 95% of its stamped burst pressure
- Up to full vacuum capabilities without the need of an additional support member
- Longer service life under cyclic or pulsating conditions
- Constructed using thicker materials providing greater resistance to corrosion

Pages 7-15 of this guide provide a brief overview of the various tension and reverse acting design rupture discs, holders, accessories and options offered by Continental Disc Corporation. For detailed information regarding a specific design, refer to the bulletin noted at the end of each product overview, or contact the factory directly.



## HPX™ Rupture Disc



## SANITRX HPX™ Rupture Disc



### FEATURES

- The **HPX™ & SANITRX HPX™ rupture discs** are high precision scored reverse acting rupture discs that offer proven performance in excess of 250,000 cycles at a 95% operating ratio.
- Choice of 90% or 95% maximum recommended operating ratio
- Safety ratio of 1 to 1 or less. If the rupture disc becomes damaged, it will relieve at or below the rated burst pressure.
- Non-fragmenting design
- All SANITRX HPX™ rupture discs include sanitary, environmentally friendly, non-toxic packaging

### SPECIFICATIONS:

**Sizes:** 1" - 8" (25mm-200mm) diameter

**Burst pressure:**

15 to 1000 psig @ 72°F  
(1.03 to 68.9 barg @ 22°C)

**Features:**

- One holder for a wide range of burst ratings
- Wide range of burst pressures, materials and sizes

**Service:**

Static, pulsating or cyclic conditions; excellent for use under pressure relief valve

**Material:**

316 SS, HASTELLOY® C, Nickel, MONEL®\*\* and INCONEL®\*\*, other materials available

**Tagging:**

Three dimensional stainless steel flow direction tag attached to all sizes

**Manufacturing Range:**

ZERO is standard; -5% or -10% optional

**Holder:**

HPX™ Insert Holder Carbon Steel, 316SS, MONEL®, HASTELLOY® C, pretorqued available

**Alarm System:**

B.D.I.® Alarm System compatible

### SPECIFICATIONS:

**Sizes:** 1" - 3" (25mm-80mm) diameter

**Burst pressure:**

10 to 250 psig @ 72°F  
(0.69 to 17.2 barg @ 22°C)

**Features:**

- The SANITRX HPX™ rupture disc is a scored reverse acting rupture disc designed specifically for the pharmaceutical, biotech, food and beverage industries.
- Meets all ASME BPE and USP class VI criteria
- Precision scoring on the vent side of the dome assures optimum clean ability and improves rupture disc performance in severe service applications

**Service:**

Static, pulsating or cyclic conditions; excellent for use under pressure relief valve

**Material:** 316 SS, HASTELLOY® C, other materials available

**Tagging:** Three dimensional stainless steel vertical flow direction tag attached to all sizes

**Manufacturing Range:**

ZERO is standard; -5% or -10% optional

**Installation:**

Available to fit between industry standard sanitary ferrules, NA-connect flanges and SANITRX® fittings

**Alarm System:**

B.D.I.® Alarm System compatible

\* HASTELLOY is a registered trademark of Haynes International

\*\*INCONEL and MONEL are registered trademarks of the Inco Family of Companies.

## ULTRX® and LOTRX® Rupture Discs

These scored reverse acting rupture discs utilize our failure initiating indents, a highly accurate manufacturing method to achieve and control a burst pressure at close tolerances, plus a precision semicircular score to provide a clean, consistent opening pattern.



### ULTRX® Rupture Disc

**Sizes:** 1" - 12"  
(25mm - 300mm) diameter

**Burst pressure:**  
15 to 1000 psig @ 72°F  
(1,03 to 68,9 barg @ 22°C)

### LOTRX® Rupture Disc

**Sizes:** 1" - 8"  
(25mm - 200mm) diameter

**Burst pressure:**  
1.5 to 39.9 psig @ 72°F  
(0,103 to 2,75 barg @ 22°C)

### COMMON FEATURES INCLUDE:

- **ULTRX®** operates in GAS, VAPOR or FULL LIQUID service conditions.
- **LOTRX®** operates in gas or liquid service conditions.
- Zero manufacturing range as standard, allowing the disc to be operated to 90% of its rated burst pressure (for burst pressures 40 psig and above. Below 40 psig, operation is to 90% of the lower portion of the burst tolerance range).
- Safety ratio of 1.5 or less. In the event of rupture disc damage, burst will occur within 1.5 times the rated burst pressure (LOTRX® safety ratio: 1.0).
- Inherent with most reverse acting type of rupture discs on the market, these discs will operate in pressure-to-vacuum cycling applications without an additional vacuum support component, for burst pressures 5 psig (0,34 barg) and above.
- Encapsulating rings on ULTRX® and LOTRX® provide perfect alignment and minimize seal load sensitivity.
- Three-dimensional stainless steel flow tag provides immediate verification of proper installation. The tag is stainless steel for resistance to corrosion.
- Designed for non-fragmentation.
- Unique holder utilizes disc alignment pins to aid proper disc orientation in holder, and a J-Hook to aid proper orientation relative to flow direction between companion flanges.
- Thicker disc material (than tension type rupture disc of similar burst pressure) adds corrosion resistance.

### SPECIFICATIONS:

- Sizes:** Shown above; consult the factory for larger sizes
- Operating pressure:**  
Pressure: Up to 90% of rated burst pressure (for burst pressures 40 psig and above)  
Temperature: To 1000°F (538°C)
- Service:** Static, pulsating or cyclic conditions; excellent for use under pressure relief valve
- Material:** HASTELLOY®\* C, INCONEL®\*\*, Nickel, MONEL®\*\*, or 316SS; other materials available
- Tagging:** Three dimensional stainless steel flow tag attached to all sizes
- Manufacturing range:** ZERO is standard; -5% or -10% optional
- Seat configuration:** Flat seat
- Holder:** ULTRX® and LOTRX® holders, each with unique alignment pin pattern and J-Hook as standard, or QUICK-CHANGE®, pretorqued available
- Alarm system:** B.D.I.® Alarm System compatible (consult factory for B.D.I.® Alarm System with LOTRX® Rupture Disc)
- Options:** Rupture Disc: Process side - liner  
Outlet side - protective cover  
Holder: Gauge tap, TEFLON®\*\*\* coating, special gasket surface finish, tantalum lining

\* INCONEL and MONEL are registered trademarks of the Inco family of companies.

\*\*HASTELLOY is a registered trademark of Haynes International.

\*\*\*TEFLON is a registered trademark of E.I. du Pont de Nemours and Company used under license.



RCS Rupture Disc Assembly



The **RCS Rupture Disc** is a reverse acting, crossscored, solid metal rupture disc, providing reliable pressure relief protection, easy installation, and retrofit to your pre-existing piping arrangement.

**SPECIFICATIONS:**

- Sizes:** 1" - 32"  
(25mm - 800mm) diameter
- Operating conditions:**  
Pressure: Up to 90% of rated burst pressure  
Temperature: To 1000°F (538°C)
- Burst pressure:** 20 to 1000 psig @ 72°F  
(1,38 to 68,9 barg @ 22°C)  
Depending on size
- Service:** Gaseous, static, pulsating or cyclic conditions; may be used under pressure relief valve
- Material:** Nickel, 316SS, MONEL®, INCONEL® and HASTELLOY® C
- Tagging:** Three-dimensional stainless steel flow tag attached to all sizes
- Seat type:** Flat seat
- Holder:** RCS Insert Holder, pretorqued available
- Alarm system:** B.D.I.® Alarm System compatible
- Options:**
  - Rupture Disc: Process side - TEFLON® liner  
Outlet side - protective cover
  - Holder: J-Hook, coatings, special gasket surface finish

SANITRX® Rupture Disc



The **SANITRX® Rupture Disc** is a reverse acting, solid metal rupture disc with Continental's "failure initiating indents," designed to provide overpressure protection in sanitary environments. Also available, the SANITRX LP® Rupture Disc, with lower pressures and a much lower K<sub>R</sub> factor, available in 1"- 3" (25-80mm) size.

**SPECIFICATIONS:**

- Sizes:** 1½" - 4"  
(40mm - 100mm) diameter
- Operating conditions:**  
Pressure: Up to 90% of rated burst pressure  
Temperature: Rated up to 450°F (232°C),  
Depending on gasket material
- Burst pressure:** 14 to 500 psig @ 72°F  
(0,965 to 34,5 barg @ 22°C)  
Depending on size
- Service:** Gaseous, static, pulsating or cyclic conditions; may be used under pressure relief valve
- Material:**
  - Disc: Nickel, MONEL®, 316SS, INCONEL®, HASTELLOY® C, Aluminum and Tantalum
  - Gasket: VITON®, Buna-N, Silicone, EPDM, PTFE, TEFLON®, and Platinum Cured Silicone
- Tagging:** Three-dimensional stainless steel flow tag attached to all sizes
- Seat type:** Flat seat
- Holder:** Designed to install directly between sanitary tube O.D. connections using a sanitary clamping device
- Alarm system:** B.D.I.® Alarm System compatible

\* INCONEL and MONEL are registered trademarks of the Inco family of companies.  
 \*\*HASTELLOY is a registered trademark of Haynes International.  
 \*\*\*TEFLON is a registered trademark of E.I. du Pont de Nemours and Company used under license.  
 \*\*\*\*VITON® is a registered trademark of DuPont Performance Elastomers.

## TENSION TYPE

### MICRO X® Cross Scored Rupture Disc



The MICRO X® Rupture Disc is a cross-scored flat seat tension type rupture disc. It is designed for non-fragmentation with a four-petal opening.

#### SPECIFICATIONS:

**Sizes:** 1" - 36"

(25mm - 900mm) diameter

#### Operating conditions:

Pressure: Up to 80% of rated burst pressure

Temperature: To 1000°F (538°C)

Depending on material

**Burst pressure:** 15 to 3600 psig @ 72°F  
(1,03 to 248 barg @ 22°C)

Depending on size

**Service:** Liquid or gas, static, pulsating or cyclic conditions; may be used under a pressure relief valve

**Material:** Nickel, MONEL®, INCONEL®, Tantalum, HASTELLOY® C, or 316SS; other materials available

**Tagging:** Three-dimensional stainless steel flow tag attached to all sizes

**Seat type:** Flat seat

**Holder:** UNISERT®, QUICK-CHANGE®, CLEAN-SWEEP® or pretorqued holders

**Alarm system:** B.D.I.® Alarm System compatible

#### Options:

**Rupture Disc:** Liners, coatings, vacuum support (vacuum support not required in 1"- 4" {25mm-100mm} size)

**Holder:** J-Hook, coating, special gasket surface finish, gauge tap, tantalum lining (UNISERT®)

### Composite Flat Seat Rupture Disc



The Composite Flat Seat Rupture Disc is designed for systems requiring a lower burst pressure than offered in a MICRO X® Rupture Disc. Continental Disc Corporation's seven-hole center pattern provides a non-fragmenting design when used with a TEFLON®\* seal.

#### SPECIFICATIONS:

**Sizes:** 1 1/16" - 36"

(17,5mm - 900mm) diameter

#### Operating conditions:

Pressure: Up to 80% of rated burst pressure

Temperature: To 1000°F (538°C)

Depending on material

**Burst pressure:** 2 to 1440 psig @ 72°F  
(0,138 to 99,3 barg @ 22°C)

Depending on size

**Service:** Liquid or gas, static, pulsating or cyclic conditions; may be used under pressure relief valves

#### Material:

**Top Section:** 316SS, Nickel, INCONEL®, MONEL®, Tantalum, or HASTELLOY® C

**Seal:** TEFLON® or metal; Other materials available

**Tagging:** Three-dimensional stainless steel flow tag attached to 1" (25mm) and above

**Seat type:** Flat seat

**Holders:** UNISERT®, Tite-Seal, Screw Type, QUICK-CHANGE®, Sanitary, CLEAN-SWEEP® or pretorqued available

**Alarm system:** B.D.I.® Alarm System compatible

#### Options:

**Rupture Disc:** Liners, protective rings, gaskets, vacuum support

**Holder:** J-Hook, coating, special gasket surface finish, gauge tap, tantalum lining (UNISERT®)

\*TEFLON is a registered trademark of E.I. du Pont de Nemours and Company used under license.

\*\*INCONEL and MONEL are registered trademarks of the Inco family of companies.

\*\*HASTELLOY is a registered trademark of Haynes International.

## Standard Rupture Discs



**A Standard Rupture Disc** is a solid metal, differential pressure relief device with an instantaneous, full-opening, non-reclosing design.

### SPECIFICATIONS

**Sizes:** ¼" - 30"  
(6,0mm - 750mm) diameter

#### Operating conditions:

Pressure: Up to 70% of rated burst pressure  
Temperature: To 1000°F (538°C)  
Depending on material

**Burst pressure:** 3 to 80,000 psig @ 72°F  
(0,207 to 5516 barg @ 22°C)  
Depending on size

**Service:** Liquid or gas, static, cyclic and pulsating conditions

**Material:** Aluminum, Nickel, INCONEL<sup>®\*\*</sup>, MONEL<sup>®\*\*</sup>, Silver, Tantalum, HASTELLOY<sup>®\*\*\*</sup> C and 316SS; other materials available

**Tagging:** Three-dimensional stainless steel flow tag attached to 1" (25mm) and above

**Seat type:** 30 degree or flat seat

**Holders:** Insert, Full Bolted, Union, Screw-Type, Tite-Seal or QUICK-CHANGE<sup>®</sup> holders

**Alarm system:** B.D.I.<sup>®</sup> Alarm System compatible

#### Options:

Rupture Disc: Liners, coatings, protective rings, gaskets, vacuum or handling supports and dent protectors

Holder: J-Hook, coating, special gasket surface finish, gauge tap

## Composite Rupture Discs



**The Composite Rupture Disc** is designed for systems requiring a lower burst pressure than offered in Standard discs. Continental Disc Corporation's seven-hole center pattern is designed for non-fragmentation when used with a TEFLON<sup>®\*</sup> seal.

### SPECIFICATIONS

**Sizes:** 1" - 30"  
(25mm - 750mm) diameter

#### Operating conditions:

Pressure: Up to 80% of rated burst pressure  
Temperature: To 1000°F (538°C)  
Depending on material

**Burst pressure:** 2 to 1440 psig @ 72°F  
(0,138 to 99,3 barg @ 22°C)  
Depending on size

**Service:** Liquid or gas, static, pulsating or cyclic conditions; may be used under pressure relief valves

**Material:** Top Section: 316SS, Nickel, INCONEL<sup>®</sup>, MONEL<sup>®</sup>, Tantalum, Aluminum, or HASTELLOY<sup>®</sup> C.

**Seal:** TEFLON<sup>®</sup> or metal. Other materials available

**Tagging:** Three-dimensional stainless steel flow tag attached to 1" (25mm) and above

**Seat type:** 30 degree

**Holders:** Insert, Full Bolted, Union, or QUICK-CHANGE<sup>®</sup> holders

**Alarm system:** B.D.I.<sup>®</sup> Alarm System compatible

#### Options:

Rupture Disc: Liners, protective rings, gaskets, vacuum or handling supports

Holder: J-Hook, coating, special gasket surface finish, gauge tap

\*TEFLON is a registered trademark of E.I. du Pont de Nemours and Company used under license.

\*\*INCONEL and MONEL are registered trademarks of the Inco family of companies.

\*\*\*HASTELLOY is a registered trademark of Haynes International.

# ULTRA-LOW PRESSURE

## CAL-VAC® Rupture Disc Assembly

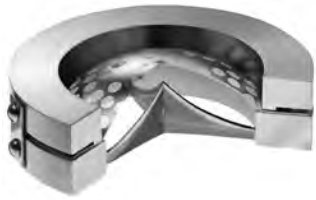

Insert Style



Sanitary Style

The **CAL-VAC® Rupture Disc Assembly** is a highly accurate pressure relief device for protecting vessels and equipment against damaging vacuum conditions.

### Proven features include:

- Designed to open on vacuum within a 6" water column spread
- Pressure setting starting at 1" water column
- Can be operated to within 1" water column or 90%, dependent upon rating
- Dual directional pressure protection (positive or negative)
- Designed for non-fragmentation

### SPECIFICATIONS:

**Sizes:** Insert Style 3" - 12" (80mm - 300mm) diameter  
Sanitary Style 3" - 10" (80mm - 250mm) diameter

### Operating conditions:

**Vacuum Pressure:** Up to 90% of minimum vacuum pressure set point or within 1" of water column, whichever is greater

**Positive pressure:** Up to 80% of rated burst pressure

**Temperature:** To 400°F (204°C)

### Burst pressure:

**Vacuum:** 6" water column spread between 1" to 30" of water column  
Depending on size

**Positive:** 2 to 150 psig (0,138 - 10,3 barg)  
Depending on size

**Seat type:** Flat seat

**Holder:** Sanitary, insert type or QUICK-CHANGE®

**Alarm system:** B.D.I.® Alarm System compatible

## POS-A-SET® Rupture Disc Assembly



Insert Style



Sanitary Style

The **POS-A-SET® Rupture Disc Assembly** is a highly accurate pressure relief device for protecting vessels and equipment against damaging positive pressure conditions.

### Proven features include:

- Designed to open on positive pressure within a 6" water column spread
- Positive pressure setting starting at 1" water column
- Can be operated to within 1" water column or 90%, dependent upon rating
- Dual directional pressure protection (positive or negative)
- Designed for non-fragmentation

### SPECIFICATIONS:

**Sizes:** Insert Style 3" - 12" (80mm - 300mm) diameter  
Sanitary Style 3" - 10" (80mm - 250mm) diameter

### Operating conditions:

**Positive Pressure:** Up to 90% of minimum positive pressure set point or within 1" of water column, whichever is greater

**Vacuum:** Up to 80% of rated pressure in the vacuum direction

**Temperature:** To 400°F (204°C)

### Burst pressure:

**Positive:** 6" water column spread between 1" to 30" of water column  
Depending on size

**Vacuum:** To full vacuum.

**Seat type:** Flat seat

**Holder:** Sanitary, insert type or QUICK-CHANGE®

**Alarm system:** B.D.I.® Alarm System compatible



## ENVIRO-SEAL Rupture Disc



The **ENVIRO-SEAL Rupture Disc** is a flat composite rupture disc, designed to provide economical isolation for low pressure atmospheric storage vessels or to isolate the downstream side of a pressure relief valve.

ENVIRO-SEAL Rupture Discs are available in three designs:

- Type I: Burst in one direction only
- Type II & III: Burst in either direction, positive or vacuum, at the same burst pressure

### SPECIFICATIONS:

**Sizes:** 2" - 36"  
(50mm - 900mm) diameter

**Operating conditions:**  
Pressure: Up to 50% of rated burst pressure  
Temperature: To 400°F (204°C)

**Burst pressure:** 1 to 59 psig @ 72°F  
(0,069 to 4,07 barg @ 22°C)  
Depending on size

**Service:** Gas or liquid

**Material:**  
Top section(s): 316SS, Nickel, INCONEL®, MONEL®, Tantalum, or HASTELLOY® C; other materials available  
Seal(s): TEFLON® or Polyethylene (at the discretion of Continental Disc Corporation)  
Gaskets: Non-asbestos both sides

**Tagging:** Three-dimensional stainless steel flow tag attached

**Alarm system:** B.D.I.® Alarm System compatible

**Seat type:** Flat Seat

**Holder:** Designed to mount directly between standard bore ANSI, DIN or JIS companion flanges

## Tite-Seal Rupture Disc Assemblies



The **Tite-Seal Rupture Disc Assembly** is an economical "throwaway" sealed unit available with 1/4", 3/8", or 1/2" MPT inlet connections and outlet configurations with an MPT connection, muffled, or free vent.

### SPECIFICATIONS:

**Disc type:**  
1/2" Standard Preformed Rupture Disc

**Operating conditions:**  
Pressure: Up to 70% of rated burst pressure  
Temperature: To 400°F (204°C)

**Burst pressure:** 65 to 3000 psig @ 72°F  
(4,48 to 207 barg @ 22°C)

**Material:** Silver, Aluminum, MONEL®, Nickel, INCONEL®, HASTELLOY® C or 316SS

**Options:** Vacuum support, TEFLON® coating or gasket  
11/16" Composite Rupture Disc:

**Operating conditions:**  
Pressure: Up to 80% of rated burst pressure  
Temperature: To 400°F (204°C)  
Burst pressure: 30 to 1000 psig @ 72°F  
(2,07 to 68,9 barg @ 22°C)

**Material:**  
Top Section: 316SS, MONEL®, INCONEL®, Nickel or HASTELLOY® C; other materials available

**Seal:** TEFLON® or Silver

**Vacuum support:** 316SS or HASTELLOY® C

**Holder material:** Brass

\*INCONEL and MONEL are registered trademarks of the Inco family of companies.

\*\*HASTELLOY is a registered trademark of Haynes International.

\*\*\*TEFLON is a registered trademark of E.I. du Pont de Nemours and Company used under license.

# TENSION TYPE

## GRAFSERT® Rupture Disc

Graphite Rupture Disc with armored ring



**GRAFSERT® Rupture Discs** are machined from a monolithic piece of graphite and impregnated with phenolic. Graphite discs are corrosive resistant to many chemicals.

### SPECIFICATIONS

**Sizes:** ½” - 24”  
(13mm - 600mm) diameter

**Operating conditions:**

Pressure: Up to 80% of rated burst pressure. 90% available in specific static conditions; consult the factory for details

**Temperature:** To 700°F (371°C)

**Burst pressure:** 0.25 to 720 psig @ 72°F (0,017 to 49,6 barg @ 22°C)  
Depending on size

**Service:** Gas or liquid

**Material:** Graphite impregnated with phenolic

**Seat configuration:** Flat seat

**Holder:** Installs directly between 150# or 300# ANSI class flanges and equivalent classes DIN or JIS flanges (separate holder not required)

**Tagging:** Stainless steel tag attached

**Alarm system:** B.D.I.® Alarm System compatible

**Options:** Coatings, liners, armor ring, vacuum support, gaskets, high temperature assembly

## ICON Rupture Disc



**The ICON Rupture Disc** is a cross-scored, non-fragmenting design solid metal rupture disc specifically designed to protect transportation vessels like intermodal tank containers (common in Europe and Asia), railroad tank cars, tank trucks, and other vessels that transport liquids or gas products.

### SPECIFICATIONS

**Sizes:** 65mm and 80mm

**Operating conditions:**

Pressure: Up to 80% of rated burst pressure; full vacuum

**Standard Burst pressures:**

3,67; 4,10 or 4,84 barg at 20°C; other pressures available

**Service:** Liquid or gas

**Material:** Nickel disc standard, with 316SS inlet /outlet rings; other materials available

**Option:** TEFLON®\* liner

**Seat type:** Flat seat

**Holders:** Designed to mount directly to tank flanges

**Tagging:** Stainless steel tag attached

**Alarm system:** B.D.I.® Alarm System compatible

**Seat type:** Flat Seat

**Holder:** Designed to mount directly between standard bore ANSI, DIN or JIS companion flanges

## Tanksert Rupture Disc



**The Tanksert Rupture Disc** is designed for use on railroad tank cars, over the road tank trucks and other transportable vessels. It is designed to fit both threaded and bolted type Safety Vent Assemblies.

**Two styles are available:**

- 1. Tanksert Rupture Disc with Bee Screen** is used for applications that require protection against bees, insects or other airborne particles from entering the tank after a rupture disc opening has occurred.
- 2. Tanksert Rupture Disc** without bee screen.

### SPECIFICATIONS

**Size:** 2” to fit Safety Vent Assembly

**Operating pressure:**

Up to 80% of rated burst pressure

**Standard Burst pressures:**

Stocked and available for immediate shipment in:  
 25 to 30 . . . .psig @ 72°F  
 40 to 45 . . . . “ “  
 55 to 60 . . . . “ “  
 70 to 75 . . . . “ “  
 95 to 100 . . . . “ “  
 155 to 165 . . . . “ “

**Material:** Stainless steel rupture disc components with TEFLON® seal; Bee screen of #14 or #20 mesh stainless steel

\*TEFLON is a registered trademark of E.I. du Pont de Nemours and Company used under license.

Continental Disc Corporation **Vent Panels** are designed to allow full, instantaneous opening, thus minimizing structural or mechanical damage that may be caused by the deflagration of dust, gas or mist.

**Our Vent Panels feature:**

- Full, instantaneous opening under dynamic or static pressure conditions
- Designed for non-fragmentation
- Available in square, rectangular or circular configurations
- Interchangeable with many existing applications
- B.D.I.® Alarm System compatible

**Vent Panel Types**

Continental Disc Corporation vent panels are offered in the following types of construction:

**VP Series:**

The VP series vent panel is a flat, scored aluminum panel, epoxy coated, for applications requiring protection to as low as 1 psig. This panel may be used for positive pressure or vacuum pulsating conditions.

**CP Series:**

The CP series flat composite vent panel is excellent for applications requiring cyclic conditions (positive to negative pressures), low opening pressures and the need for stainless steel construction.

**SFC and CFC Series:**

The SFC and CFC series prebulged vent panels are excellent for applications operating up to full vacuum. The SFC series are prebulged, circular, solid aluminum vent panels with a handling or vacuum support. The CFC series are prebulged, circular composite vent panels with a handling or vacuum support, usually made of 316SS and Teflon components.

**CFR and CFS Series Formed Vent Panels:**

The CFR (rectangular) and CFS (square) series are prebulged 316SS vent panels with vacuum support and Teflon seal. The CFR and CFS vent panels have an operating ratio of up to 80% of the minimum tagged rating.

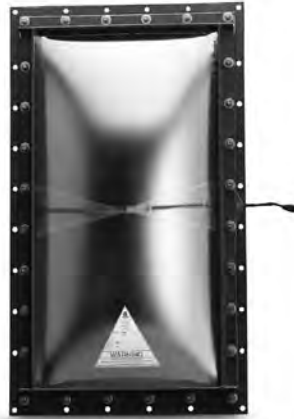

**SPECIFICATIONS:**

**Sizes:**

Rectangular or Square:  
12" x 12" - 44" x 69". (30 cm x 30 cm - 112 cm x 175 cm)  
Circular: 10" - 44"  
(25 cm - 112 cm) diameter

**Operating conditions:**

Flat panels: Up to 50% of rated burst pressure for positive or vacuum conditions

**Preformed (prebulged):**

Up to 80% of rated burst pressure for positive pressure and up to full vacuum

**Temperature:** To 450°F (232°C)

**Burst pressure:** 1 to 10 psig @ 72°F (0,069 to 0,689 barg @ 22°C)

**Service:** Gaseous, static, pulsating or cyclic

**Holder:** Lightweight flange construction

**Alarm system:** B.D.I.® Alarm System compatible

**Options:** Coatings, vacuum support, dent protector,



The Continental Disc state of the art **B.D.I.® Alarm System** is designed specifically for use with Continental Disc Corporation rupture discs or vent panels.

The B.D.I.® Alarm System consists of an alarm strip, interfaced with a monitoring unit, computer, annunciator panel, control panel or other equipment. The alarm system is activated by the opening of a rupture disc or vent panel.

The B.D.I.® Alarm System is a normally closed, low-powered circuit. When a rupture disc opens, the alarm strip is severed, interrupting the circuit which activates a monitoring device. This device is used to signal that an overpressure condition has occurred and that media is venting.



### Proven features include:

- Signals instantly when a rupture disc or vent panel has opened.
- Positive signal of fugitive emissions and/or the occurrence of an overpressure relief condition.
- Signals emergency equipment, control room and/or operating personnel to alter or stop a process.
- Prevents an undetected open vent line once an overpressure condition occurs.

### SPECIFICATIONS:

The B.D.I.® Alarm may be used on the following Continental Disc Corporation products:

#### Tension type rupture discs

- Standard
- Composite (30° Seat or Flat Seat)
- MICRO X® scored
- ENVIRO-SEAL
- Graphite

#### Reverse acting rupture discs

- HPX™
- HPX SANITRX™
- ULTRX®
- MINITRX®
- STAR X®
- LOTRX® (3" and larger sizes)
- SANITRX®
- SANITRX LP®
- RCS
- ZAP
- KBA

#### Ultralow pressure rupture discs

- CAL-VAC®
- POS-A-SET®

#### Vent Panels

#### B.D.I.® Alarm Strip operating limits:

Maximum current: 50 milliamps  
 Maximum voltage: 24 VDC RMS  
 Temperature: -40°F to 400°F  
 (-40°C to 206°C)

#### Monitor operating limits:

Power source:

115 / 230VAC @ 50 / 60 Hz  
 or 24 or 12 VDC ±1 volt

Output relay contacts rating:

2 AMPS @ 120 V resistive  
 1 AMP @ 120 V inductive  
 2 AMPS @ 24 V inductive

Operating temperature range:

To 122°F (50°C)

#### Construction:

- The standard monitor unit has a NEMA 1 wall mounted enclosure.
- Enclosures are available for other NEMA classifications.
- Models SB-100, BB-100, BB-400 and MTB-700 are intrinsically safe designs.
- Monitors specifically designed to meet special requirements are available.
- MTB-700 meets several international standards for intrinsically safe design.





### Solutions...for Tough Pressure Relief Problems

Whether it's from the standard product line, or a custom-manufactured rupture disc for a one-of-a-kind application, Continental Disc Corporation has built a 40-year reputation for solving the toughest pressure relief problems.

For OEM's. Defense Industries. Space exploration program. Aircraft and aerospace manufacturers. Chemical and petrochemical industries. Food processors. Electronics industry. Countless more.

### Problem Solving

Continental Disc Corporation's custom manufacturing capabilities have been tapped for such wide-ranging projects as air conditioning units, oxygen supply systems, aircraft ejection seats, sonobouys, and the space shuttle.

The same engineering, testing, and manufacturing talent that has solved one-of-a-kind problems for worldwide industries is now available to deliver innovative solutions for your specific pressure relief problems.

### Working With Specialized Technologies...Like Yours

Solving pressure relief problems for you is the special role played by Continental Disc Corporation's Product Development Group and the Special Products Group. This pool of product development expertise has been retrofitting Continental Disc Corporation products into clients' systems for over 40 years. They are engineers who are at home with special or exotic materials, ultrahigh or ultralow burst pressures, as well as state-of-the-art processing and testing requirements.

Whether your needs are for quantities of one or one thousand, Continental Disc is ready to solve your pressure relief problems. Contact our Corporate Office in Liberty, Missouri, or one of our international offices listed on the back page.

# RUPTURE DISC HOLDERS

Continental Disc Corporation holders are available in a variety of types and styles to meet your needs. The product chart, as shown on pages 18, 19 and 20, shows which disc may be used in specific holders, and the holder options which are available.

Continental Disc Corporation offers an extensive line of holders including:

- Insert
- Bolted
- Screw Type
- Union Type
- CLEAN-SWEEP® holders
- Sanitary Holders
- QUICK-CHANGE® holders

Consult your Continental Disc Corporation representative or the factory for those applications needing additional features or modification.

## Insert Holders



Insert type rupture disc holders are flat faced assemblies that fit between two ANSI, DIN, JIS or BSI companion flanges, as shown in the photograph above. Insert holders to fit other standards are available. These holders are designed for eleven different rupture disc styles, described in paragraphs 1 through 6 below. Common features of Continental Disc Corporation's Insert Holders include:

- Fit within companion flange bolts, allowing easy installation and removal
  - Preassembly clips are standard and provide means to assemble the rupture disc and holder together before installation in piping system
  - Stainless steel flow direction nameplates permanently attached to the holder
  - Stainless steel customer identification tag permanently attached
1. **Insert** holders, designed for Standard and Composite rupture

discs, are available in 30° light or heavy lip configurations, dependent upon size.

2. The **UNISERT® Insert** holder has a flat seat configuration for use with either a MICRO X® or Composite flat seat rupture disc. Holder alignment pins and matching notches in the rupture disc provide correct rupture disc orientation in the holder. A J-Hook, along with flow direction arrows on the nameplate, aids in proper assembly installation between the companion flanges.
3. The **HPX™, ULTRX® and LOTRX® Insert** holders are designed with either a tapered or flat raised seat on the holder inlet. This design allows a uniform seal load on the mating rupture disc. Each holder has a number of round and/or oblong pins and the mating rupture disc is identically notched, providing proper rupture disc orientation in the holder. A J-Hook and flow direction arrows on the nameplates aid in the correct assembly orientation between companion flanges.
4. The **RCS Insert** holder is designed for simplicity and safety of installation with superior sealing capabilities. Three round pins located in the holder inlet and matching holes in the RCS Rupture Disc provide correct rupture disc and flow direction orientation. A tapered seat configuration allows a uniform seal load on the rupture disc.

## Full Bolted Holders



Full Bolted Holders do not need companion flanges. The proper seat configuration is machined directly into the flange. Full bolted holders are available in 30° light or heavy lip seat configurations, dependent upon size.

Welded, threaded or flat faced inlets and outlets are available. Stainless steel flow directional nameplates are provided.

## Screw Type Holders



Screw Type Holders are available for pressures ranging up to 20,000 psig. The Screw Type holder is supplied with ¼" or ½" MPT inlet threads in combination with MPT, free or muffled outlets. The ½" Standard and 11/16" Composite Rupture Disc are used in these holders. Special high pressure designs are available.

## Union Type Holders



Union Type Holders are available for pressure ranges up to 6000 psig, depending on disc size. All sizes are available with threaded or welded inlets in combination with threaded, welded or muffled outlets. Special unions are available.

## Sealing Capabilities

Continental's holder designs provide superior sealing capabilities to prevent product loss or contamination. The tapered seat configuration of Continental's HPX™, UNISERT®, RHI, ULTRX® and RCS holders outperforms other, similar designs, *without* the need for "pretorque" arrangements. However, a pretorque-able holder is available for those customers who desire one, or whose specifications require it.

## CLEAN-SWEEP® Rupture Disc Holder



The CLEAN-SWEEP® Holder is designed for systems handling viscous media processes, particularly where product build-up in a piping system may cause excessive overpressure conditions.

This holder is an ideal replacement for rupture discs installed off the leg of a pipe tee where product build-up could affect the proper operation of the rupture disc.

The CLEAN-SWEEP® Holder body is specifically designed for a rupture disc.

The rupture disc is mounted directly on the holder body adjacent to the process flow. Compared to other designs, the CLEAN-SWEEP® greatly reduces the possibility of product build-up under the rupture disc and it is available for pressures up to 1440 psig (99,3 barg).

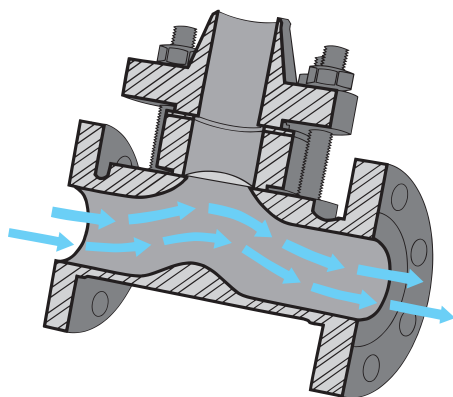

## Sanitary Holder



The Continental Disc Corporation Sanitary Rupture Disc Assembly is specifically suited for a wide range of process applications where product purity and corrosion resistance are required. These assemblies are used in dairy, distilling, brewery, food processing, pharmaceutical, canning, cosmetic, petrochemical and many other industries.

The complete assembly consists of a rupture disc, the sanitary holder and a quick release clamp. The holders are offered in straight-through, reducing or self-cleaning configurations and are available for CAL-VAC®, POS-A-SET®, Composite flat seat and MICRO X® rupture discs.

### Features include:

- Sanitary clamp connections for easy, quick installation and removal from a system
- Secure, leak-tight assembly
- Sizes 1" - 10" (25mm - 250mm)
- Available with No. 4 finish or electro polished internal, wetted surfaces
- Versatile configurations to suit many piping arrangements
- CAL-VAC® and POS-A-SET® sanitary holders may be built to 3-A standards.

## QUICK-CHANGE® Holder



The QUICK-CHANGE® Holder allows fast, easy rupture disc changeout from a system, without having to remove a pressure relief valve or outlet piping.

The QUICK-CHANGE® rupture disc cartridge slips out of the permanently mounted housing and is replaced by a second preassembled cartridge in **seconds**.

### The QUICK-CHANGE® system:

- Reduces costly downtime to a minimum.
- Allows rupture disc replacement without having to disassemble the outlet piping.

### SPECIFICATIONS:

**Size:** 1½" - 14"  
(40mm - 350mm)

**Flange Class:**  
ANSI 150# or 300#;  
Lightweight design available; Consult factory for details

**Material:** Carbon steel, 300 series stainless steel; other materials on request

**Rupture Disc:**  
Compatible with Continental Disc Corporation tension type or reverse acting type rupture discs

**Alarm System:** B.D.I.® Alarm System compatible

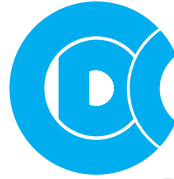

**Continental Disc<sup>®</sup>  
Corporation**

*Performance Under Pressure<sup>®</sup>*



ASME Code Symbol Stamp  
Available When Specified

China Manufacture License  
Available When Specified



Pressure Equipment Directive  
Available When Specified

Continental Disc Corporation has representatives located throughout the world.  
Contact the Continental Disc Corporation office nearest you for the authorized representative in your area.

**CORPORATE HEADQUARTERS**

Continental Disc Corporation  
3160 W. Heartland Drive  
Liberty, MO 64068-3385 USA

Phone: (816) 792-1500  
FAX: (816) 792-2277 / 5447  
E-mail: [pressure@contdisc.com](mailto:pressure@contdisc.com)  
Website: [www.contdisc.com](http://www.contdisc.com)



The Experts in Tank Storage and Process Safety

[www.assentech.co.uk](http://www.assentech.co.uk)

01726 844707